

外形尺寸图

MT-02W

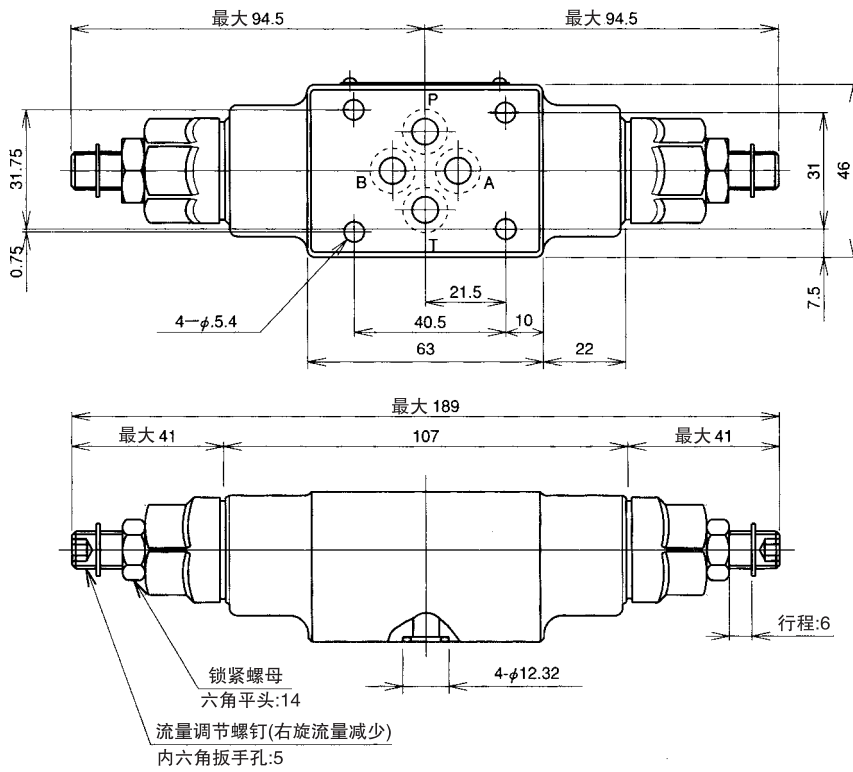

MT-02A-55

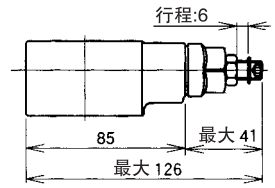

MT-02B-55

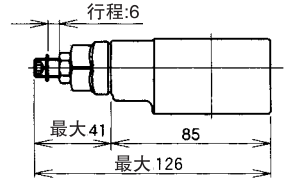

剖面结构图

MT-02W

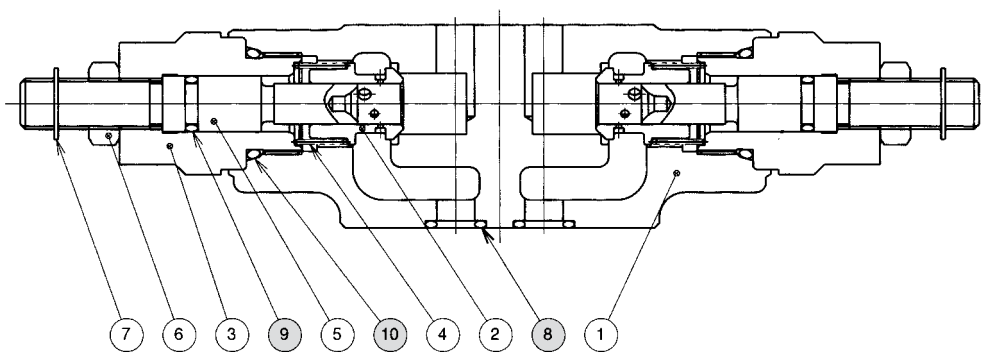

密封件一览表

件号	名称	数量		部品规格
		MT-02W	MT-02A,B	
8	O形圈	4	4	AS568-012 (NBR, HS90)
9	O形圈	2	1	JIS B2401 1B P8
10	O形圈	2	1	JIS B2401 1B P18

外形尺寸图

MT-02Wi

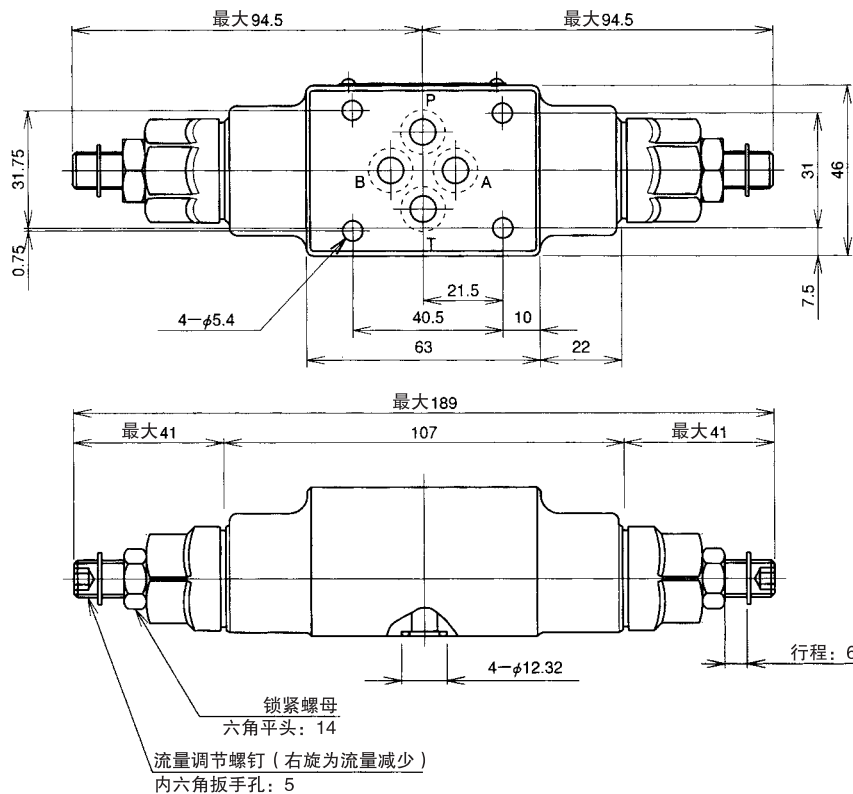

MT-02Ai

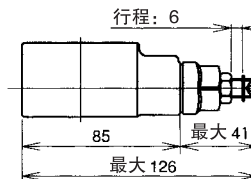

MT-02Bi

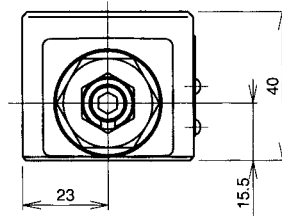
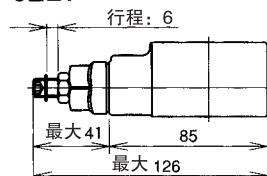

剖面结构图

MT-02Wi

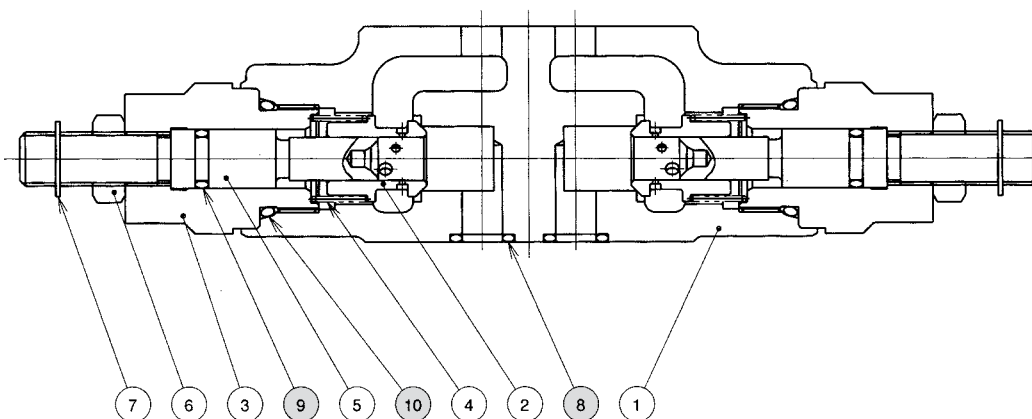

密封件一览表

件号	名称	数量		部品规格
		MT-02Wi	MT-02Ai,Bi	
8	O形圈	4	4	AS568-012 (NBR, HS90)
9	O形圈	2	1	JIS B2401 1B P8
10	O形圈	2	1	JIS B2401 1B P18

H

模块叠加阀